

DE PARK

Parking. Surprisingly simple.

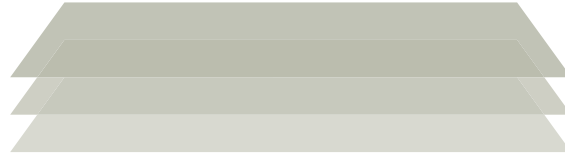

DATA SHEET **DE-62**

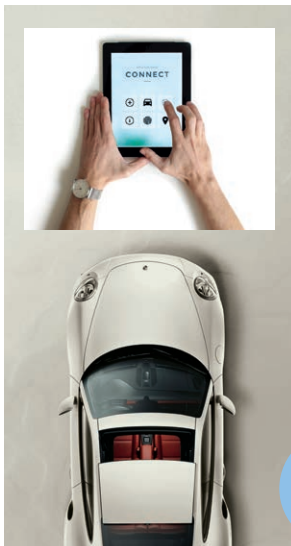
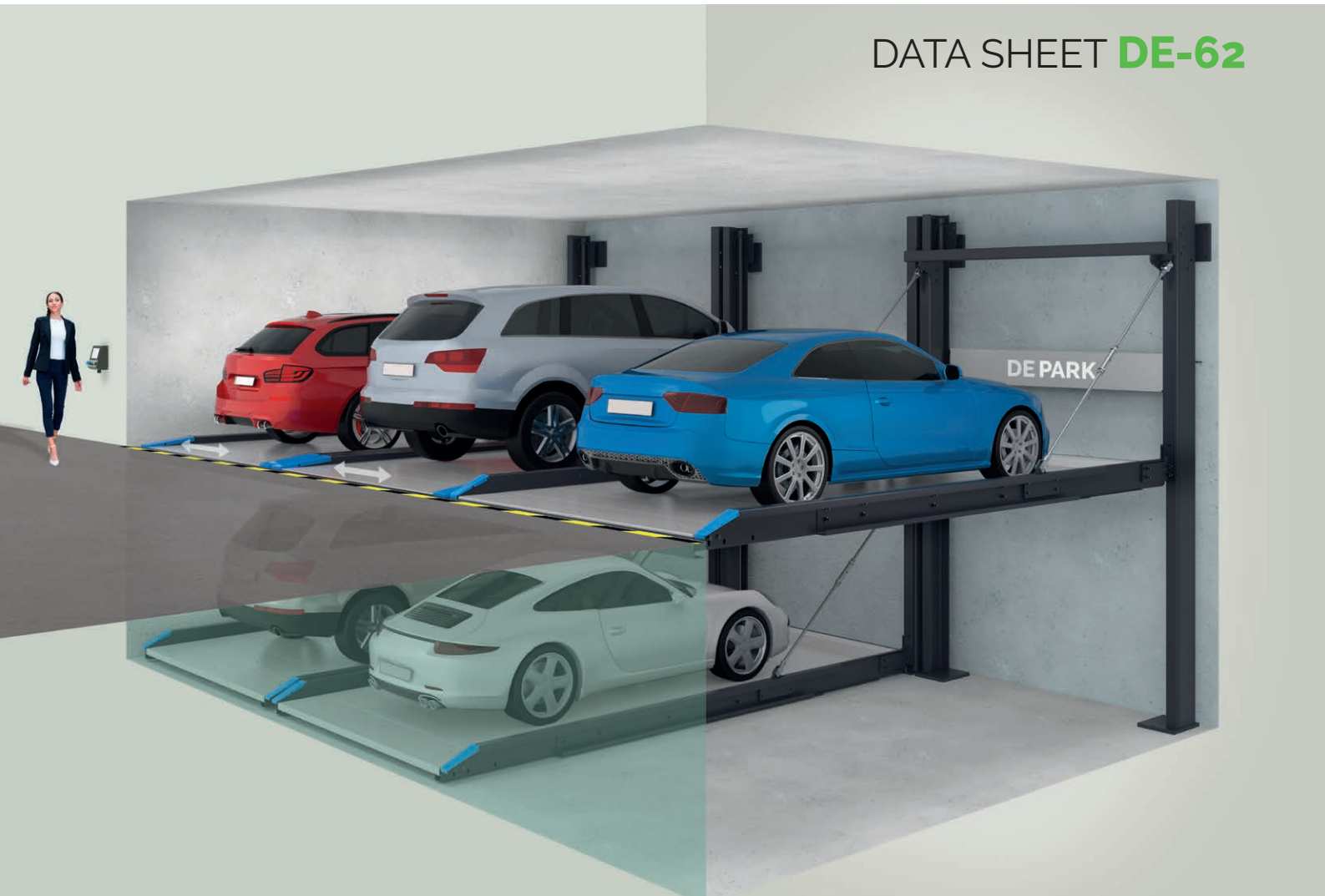

DE-62 (with pit)

**HIGH PARKING COMFORT FOR
LOW INSTALLATION HEIGHTS**

Independent parking on 2 levels
with semi-automatic control

D

Digital Parking Technologies

Made in Germany

Modular arrangement in segments,
minimum 2 segments
for 3 vehicles
are required

Access
• with gates

Platforms are horizontally accessible



- Suitable for **condominium and office buildings.**
- Usable for **trained and permanent users only.**

VEHICLE WEIGHT (max.)



- Standard**
• 2000 kg, 500 kg wheel load
- Optional**
• 2600 kg, 650 kg wheel load

THE FUNCTIONALITY OF DE-PARK DIGITAL

Our Digital Series have a combination of lifting and sliding platforms. There is one sliding platform less than lifting platforms per system. A system with up to 10 segments and 19 parking spaces is possible. You can choose your parking space with one touch at the control panel.

The example shows 3 grids with 5 parking places: 1 empty space is needed for the movement.

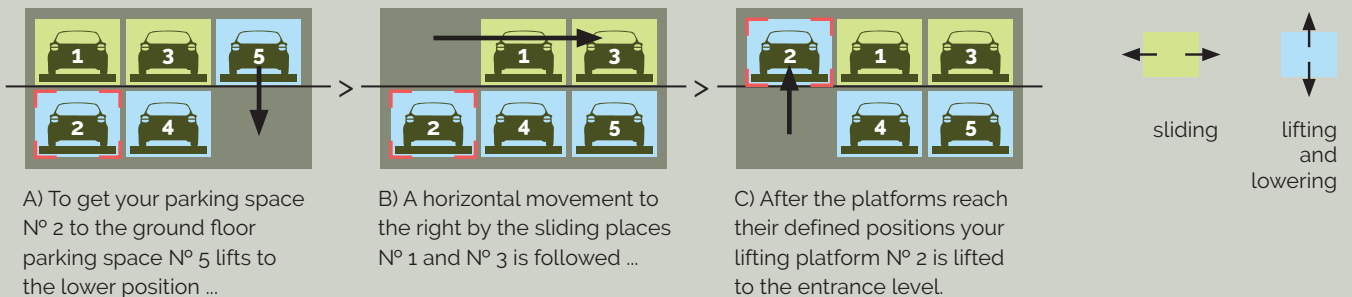

Our Standard Design for you!

LEVEL PLATFORMS instead of trapezoidal sheets

FREE ACCESS TO VEHICLE DOORS thanks to system columns in the rear area only

INNOVATIVE SLIDING GATES for a bigger manoeuvring area.



More comfort and more safety for user and vehicle.

LENGTH DIMENSIONS

DIMENSIONS in cm

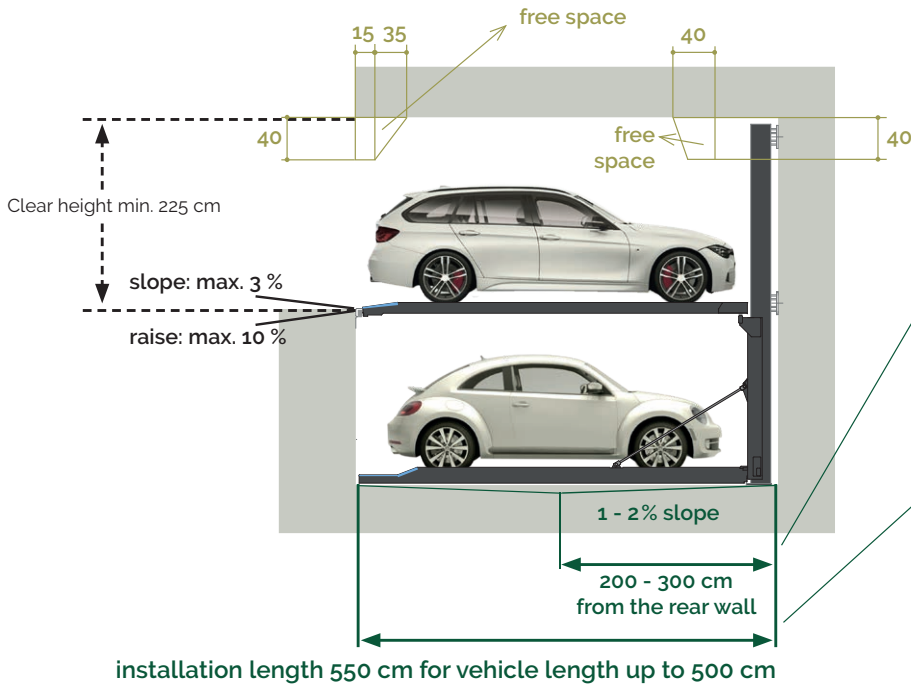

Drainage

Please provide 1 to 2 % slope in the pit floor. Distance for drainage in the area of 200 bis 300 cm from the back wall,

Installation length

Installation length of min. 550 cm for vehicle length of up to 500 cm is required. For large touring sedans an installation length of min. 560/570 cm is recommended. This enables also larger safety distances, if newer, longer vehicles are purchased.

With our innovative design the access to the parking place is very easy. Our flat profile over the complete platform provides higher comfort and driving safety. The light rise of the entrance to the parking place and the reduced side beam of the lifting platform allow an easy maneuvering and reduce the risk of wheel collision.

HEIGHT DIMENSIONS

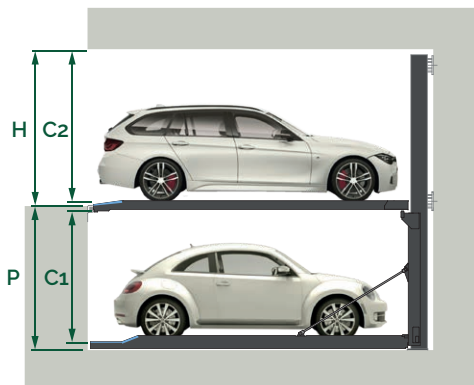

P = Pit depth
H = clear height
C1 = vehicle height bottom*
C2 = vehicle height top*

P	C1	H	C2
175 -->	150	195 -->	185
180 -->	155	200 -->	190
200 -->	175	220 -->	210
210 -->	185	230 -->	220
220 -->	195	240 -->	230
230 -->	205	250 -->	240

CLEARANCE PROFILE

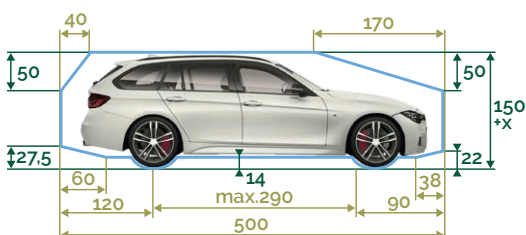

*Vehicle height

Higher cars can be parked on the platform above in case of more ceiling height.

The total vehicle height, including the roof rack, antenna, etc., must not exceed the mentioned maximum height values.

All dimensions are minimum finished dimensions.

Allow for tolerances to VOB Part C (DIN 18330, 18331) and additionally DIN 18202 (+ 30 mm / 0 mm).

WIDTH DIMENSIONS

DIMENSIONS in cm

ARRANGEMENT IN SEGMENTS

- A = parking width (clear platform width)¹
- B = segment width
- C = additional width (outer segments)²
- D = total width³

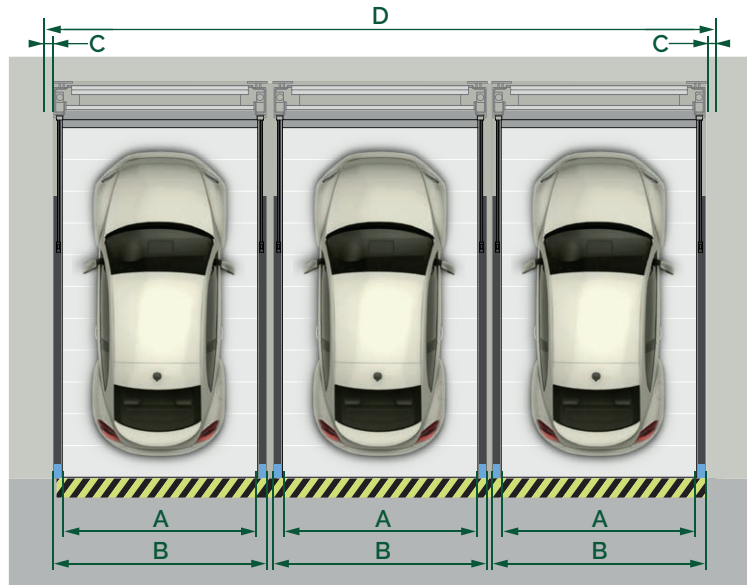

A driving lane in front of each segment is required for access.

parking width	segment width	additional width
A	B	C
230	250	10
240	260	10
250	270	10
260	280	10
270	290	10

We recommend a parking width of at least 250cm for a comfortable parking.

- ¹ The clear parking width of the sliding platform is basically 15 cm smaller than the lifting platform due to its design. Anyway, sufficient space for parking and getting in and out of the car is provided by using low side-carriers on the sliding platform.
- ² An additional width of 10 cm must be provided for each of both outer segments.
- ³ Tolerance of dimensions on the construction site = 0 to + 3 cm.

DE-62 is available with **10 segments** for **19 parking spaces** within one system.

parking width A	total width D by x segments									
	2 seg. 3 cars	3 seg. 5 cars	4 seg. 7 cars	5 seg. 9 cars	6 seg. 11 cars	7 seg. 13 cars	8 seg. 15 cars	9 seg. 17 cars	10 seg. 19 cars	
230	520	770	1020	1270	1520	1770	2020	2270	2520	
240	540	800	1060	1320	1580	1840	2100	2360	2620	
250	560	830	1100	1370	1640	1910	2180	2450	2720	
260	580	860	1140	1420	1700	1980	2260	2540	2820	
270	600	890	1180	1470	1760	2050	2340	2630	2920	

WIDTH DIMENSIONS when pillars are in front of the parking area

A	outer seg.	inner seg.	A	outer seg.	inner seg.	inner seg.	inner seg.	A	outer seg.	inner seg.	inner seg.	inner seg.	inner seg.
230	250	230	230	500	480	230	230	230	750	730	230	230	230
240	260	240	240	520	500	240	240	240	780	760	240	240	240
250	270	250	250	540	520	250	250	250	810	790	250	250	250
260	280	260	260	560	540	260	260	260	840	820	260	260	260
270	290	270	270	580	560	270	270	270	870	840	270	270	270

min. 20

OPERATION of parking systems



„FDS remote-diagnosis-system“

for a quick online analysis and reliable diagnosis for smooth operation .

Available as an option.

To be provided on site:

DSL line with internet access at the control cabinet.

OPERATION WITH GATES in semi-automatic function by Touch-Screen control unit.

Choose your parking space simply and conveniently by touch screen and follow the movement of your platform on the screen. The control unit is activated by a key-switch to ensure a safe access for permitted users only.

Access gates at the entrance of the system are required for safety reasons.

Mounting of control unit:

Wall mounting (in-wall / surface-mounted).

Alternative mounting options are available upon request.

“Stay comfortably in your car and let the system do the rest.”

Upgrade: Operation by remote control

Each user will receive a coded remote control for its parking space.

By simply pushing the button, the system will provide the selected platform.

The opening and closing of the gates by remote control is only possible when using electrically driven gates. Also external access gates and / or vehicle detectors can be operated by remote control.

GATES

Access gates are required for safety reasons (pit).

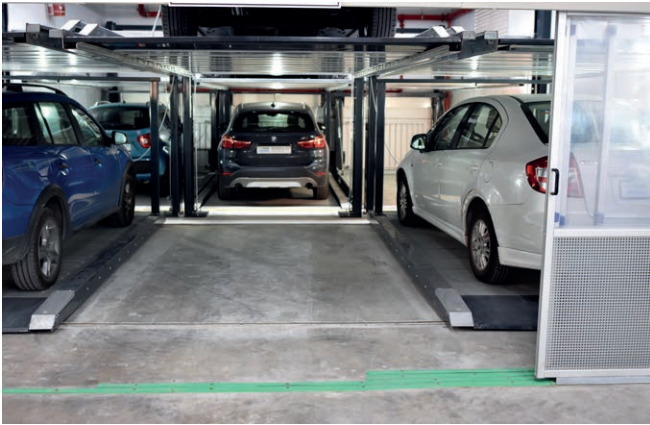
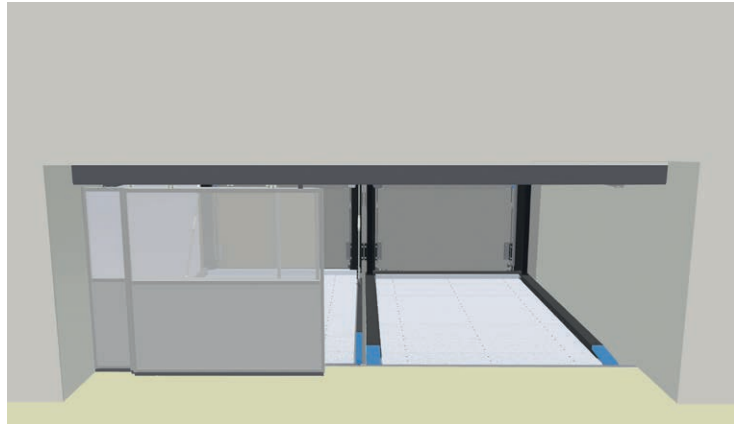

Figure above: DE-611 system for demonstration only.



Our gates offer a wider access area for more comfort and safety.

COMFORT PLUS with our new innovative gates,

we provide a bigger manoeuvring area for easy access and minimized risk of collision.

OPERATION OF GATES

Manual sliding gates (standard)

The gates are opened and closed manually. The locking mechanism is secured by a mechanical lock.

Electric sliding gates (optional)

Electric door drive: The gates are operated semi-automatically via the touch screen control unit of the entire system (function on the touch: open gate/close gate).

FRAME AND FILLUNG

The frame of the gate consists of an aluminum profile with a filling of corrugated mesh (30 mm x 30 mm x 3 mm).

Optional with polycarbonate PC-4 mm.

GUIDANCE AND DRIVE

The gate is mainly guided from above, in the lower area on the finished floor a filigree running rail (polyethylene rail 15 mm high) is pegged to the floor.

The drive technology is also located in the upper area of the frame cover to save space.

Another upgrade to the optional version: Operation of the gates via remote control.

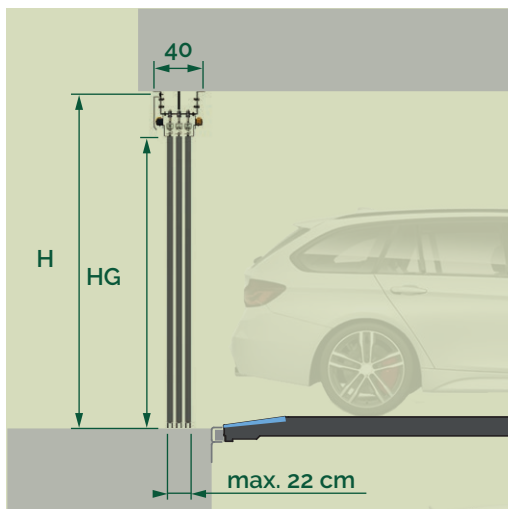

INSTALLATION DATA

H = clear height
HG = entrance height*

H	HG
225 cm	200 cm

Installation depth: 40 cm

*Notes:

The maximum vehicle height is restricted by entrance height minus 5 cm.
Other dimensions, as well as detailed technical information about our innovative sliding gates are available on request

CONSTRUCTION REQUIREMENTS (see also planning notes)

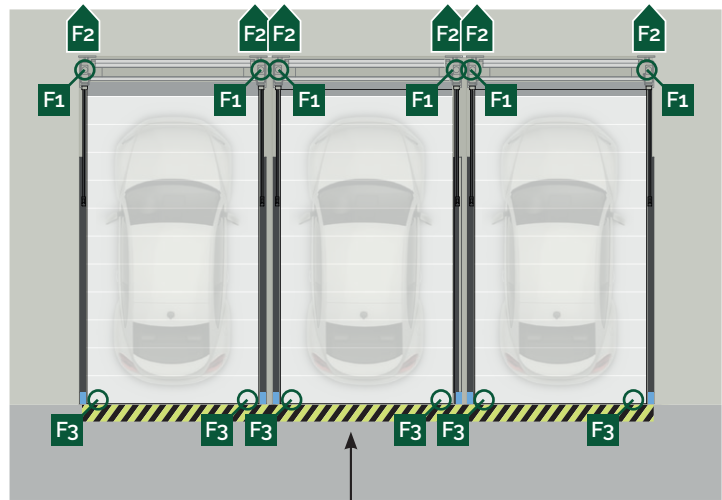
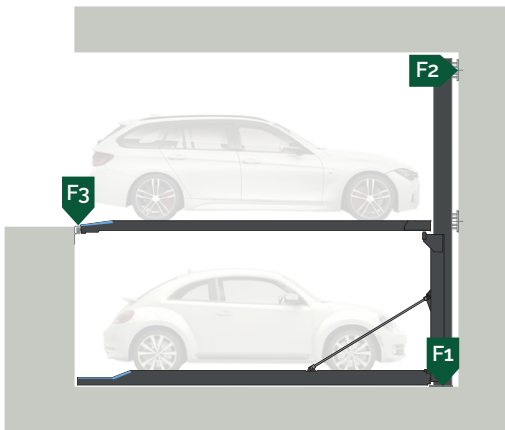

A yellow-black marking in front of each grid, 10 cm wide, according to ISO 3864 has to be provided (on-site)

FORCES TO THE STRUCTURE

	2000 kg	2600 kg
F1	25 kN	30 kN
F2	20 kN	25 kN
F3	8 kN	10 kN

F2 The force F2 can also be absorbed via the ceiling.
Ceiling fixation available upon request.

WALLS

Walls on the entry side and rear are to be made of concrete and completely flat (without protruding parts).

ELECTRIC INSTALLATION

To be provided from customer:

Item	Description
1	Electric meter
2	Fuse or automatic circuit breaker according to DIN VDE 0100, part 430, 3 x 16 A slow
3	Supply line to main switch 3 PH + N + PE according to local regs.
4	Main switch lockable
5	Connection for the protective potential equalization according to DIN 60204
6	Protective bonding all 10 m

ANCHORING & FLOOR REQUIREMENTS

The systems are directly anchored into the floor with heavy duty anchor bolts. The depth of the drill hole is approx. 13 cm. The base plate thickness must be minimum 20 cm with a concrete quality according to the static requirements of the building. Minimum requirement of the concrete quality is C20/25. The precise position of the load application points is available on request.

Power supply and system performance

- power supply: 400 Volt, 50 Hz, 3 phase
- system performance: 3,0 kW

Control cabinet

Size (depth x width x height):

253,5 mm x 511 mm x 7 11mm

Position:

The control cabinet must be placed outside the moving range of the system. We recommend positioning the cabinet near the system for a better overview of the system. The space in front of the cabinet must be minimum 1 m for opening the door and the operator.

PLANNING NOTES**Hydraulic unit**

Size (depth x width x height):
approx. 230 mm x 800 mm x 900 mm
Position: Space-saving arrangement
between the columns on the rear wall
or outside the system as per agreement.

**Maintenance, cleaning and prevention**

The systems must be serviced and
cleaned regularly according to our
operating instructions. Please ensure that
there is sufficient drainage.

**Safety fences · Barriers**

Must be installed in the pedestrian area,
accessible areas around the system as
per DIN EN ISO 13857 (on site, also during
the installation).

**Ventilation**

The parking garage must be adequately
ventilated.

**Lighting**

The parking spaces must be adequately
illuminated on site as per regulations.

**Temperature**

Temperature range from - 5 to + 40° C.
Relative humidity max. 80 %.
Please contact DE-PARK in case of different
conditions.

**Noise emissions**

According to the noise insulation regulations
for buildings to DIN 4109, a value of 30 dB (A)
must be complied with in occupied rooms
and spaces. You receive a sound insulation
package with the system for the required
30 dB (A) insulation of the structure is also
necessary. Sound reduction index min. $R_w =$
57 dB.

**Fire safety**

The garage design must fulfil the regional fire
safety provisions. The requirements can vary.
Therefore the situation must be clarified and
information obtained in advance by the
customer and then agreed and coordinated.

**Declaration of conformity**

Car Parking Systems of DE-PARK are conform
to EG-Machinery Directive 2006/42/EG and to
DIN EN 14010 (safety).

**DE PARK**

Parking. Surprisingly simple.

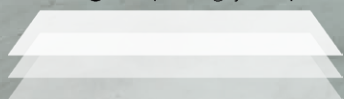
www.de-park.com

DE-PARK GmbH · Zschortauer Str. 76 · DE-04129 Leipzig

Tel.: +49 (0) 341 - 600 16 600 · Fax: +49 (0) 341 - 600 16 602 · info@de-park.com