

DE PARK

Parking. Surprisingly simple.

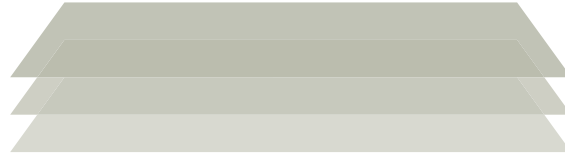

DATA SHEET **DE-613**



DE-613

Combination system: 1x DE-61 + 1x DE-63

VERY HIGH SPACE EFFICIENCY: USE ONLY ONE DRIVING LANE TO ACCESS TWO SYSTEMS

Independent parking on 2 and 3 levels
with semi-automatic control

D

Digital Parking Technologies

Made in Germany



- Suitable for **condominium and office buildings**.
- Usable for **trained and permanent users only**.

Combination system: 1x DE-61 + 1x DE-63 creates DE-613

- Modular arrangement: Minimum 2 segments in 2 rows for 8 vehicles
- Access: With gates for safety reasons (pit of DE-63)
- Passage over DE-61 to park in DE-63 system.

VEHICLE WEIGHT (max.)



Standard

- 2000 kg, 500 kg wheel load

Optional

- 2600 kg, 650 kg wheel load

THE FUNCTIONALITY OF DE-PARK DIGITAL (illustration shows DE-63)

Our Digital Series have a combination of lifting and sliding platforms. There is one sliding platform less than lifting platforms per system. A system with up to 10 segments and 19 parking spaces is possible. You can choose your parking space with one touch at the control panel.

The example shows 3 grids with 8 parking places: 1 empty space is needed for the movement.

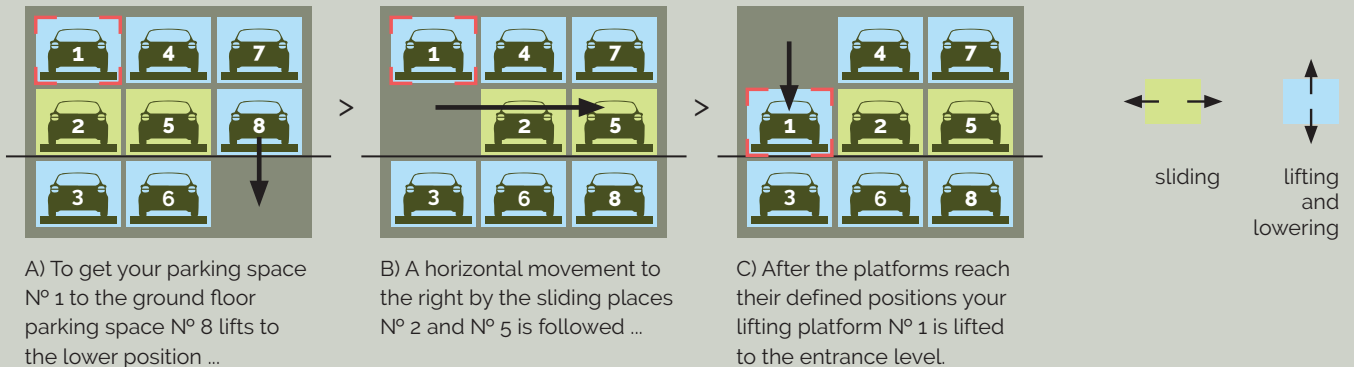

Our Standard Design for you!

LEVEL PLATFORMS instead of trapezoidal sheets

FREE ACCESS TO VEHICLE DOORS thanks to system columns in the rear area only

INNOVATIVE SLIDING GATES for a bigger manoeuvring area.



More comfort and more safety for user and vehicle.

LENGTH DIMENSIONS DE-61

DIMENSIONS in cm

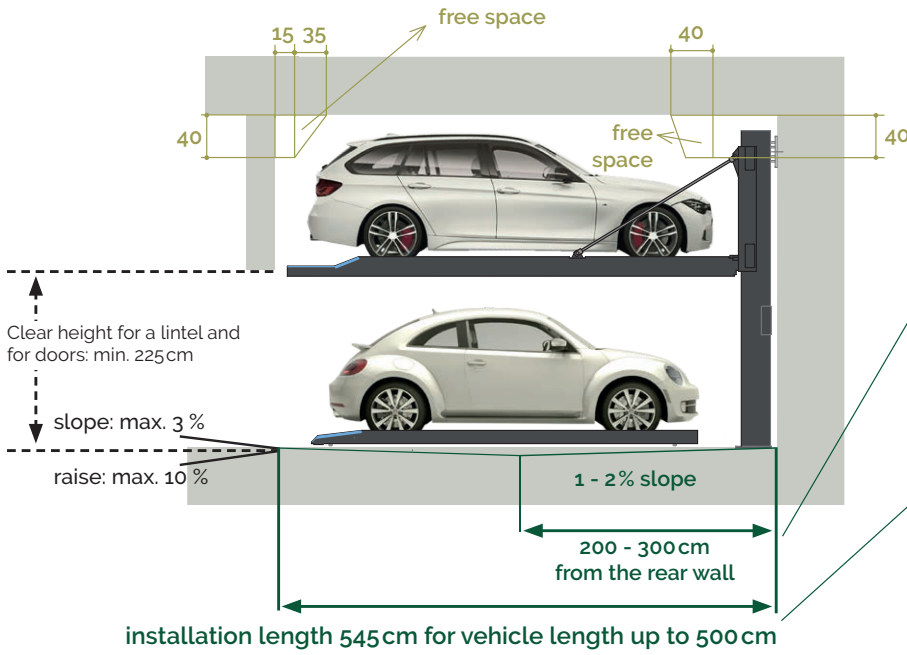

Drainage

Please provide 1 to 2 % slope in the floor. Distance for drainage in the area of 200 bis 300 cm from the back wall,

Installation length

Installation length of min. 545 cm for vehicle length of up to 500 cm is required. For large touring sedans an installation length of min. 560 cm is recommended. This enables also larger safety distances, if newer, longer vehicles are purchased.

LENGTH DIMENSIONS DE-63

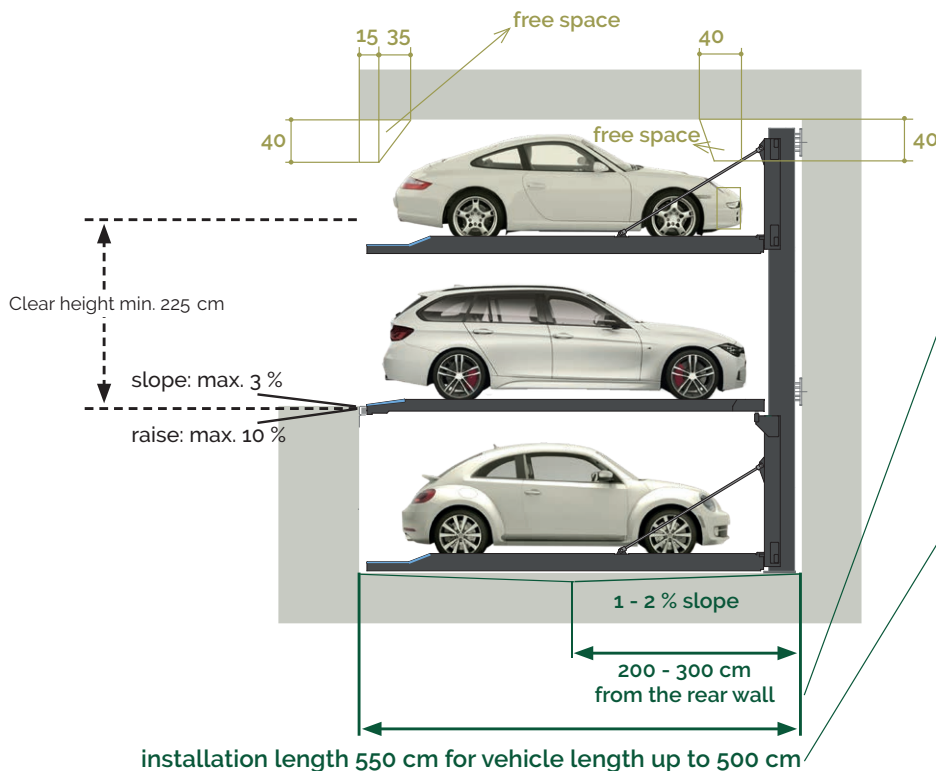

Drainage

Please provide 1 to 2 % slope in the pit floor. Distance for drainage in the area of 200 bis 300 cm from the back wall,

Installation length

Installation length of min. 550 cm for vehicle length of up to 500 cm is required. For large touring sedans an installation length of min. 560/570 cm is recommended. This enables also larger safety distances, if newer, longer vehicles are purchased.

With our innovative design the access to the parking place is very easy. Our flat profile over the complete platform provides higher comfort and driving safety. The light rise of the entrance to the parking place and the reduced side beam of the lifting platform allow an easy maneuvering and reduce the risk of wheel collision.

All dimensions are minimum finished dimensions. Allow for tolerances to VOB Part C (DIN 18330, 18331) and additionally DIN 18202 (+ 30 mm / 0 mm).

HEIGHT DIMENSIONS

DIMENSIONS in cm



All dimensions are minimum finished dimensions.

Allow for tolerances to VOB

Part C (DIN 18330, 18331)

and additionally DIN 18202

(+ 30 mm / 0 mm).

HEIGHT DIMENSIONS DE-61



H = clear height

C1 = vehicle height bottom*

C2 = vehicle height top*

H	C1	C2		C1	C2		C1	C2
330	150	150		–			–	–
340	160	150		–			–	–
350	170	150	or	160	160		–	–
360	180	150	or	170	160		–	–
370	190	150	or	180	160	or	170	170
380	200	150	or	190	160	or	180	170

HEIGHT DIMENSIONS DE-63

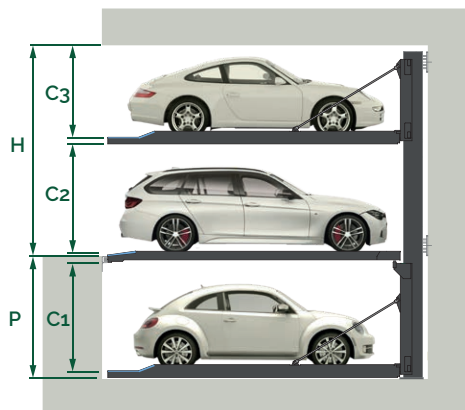

P = Pit depth

H = clear height

C1 = vehicle height bottom*

C2 = vehicle height middle*

C3 = vehicle height top*

P	H	C1	C2	C3
175	320	150	150	150
180	325	155	155	150
200	345	175	175	150
210	355	185	185	150
220	365	195	195	150
230	375	205	205	150

CLEARANCE PROFILE

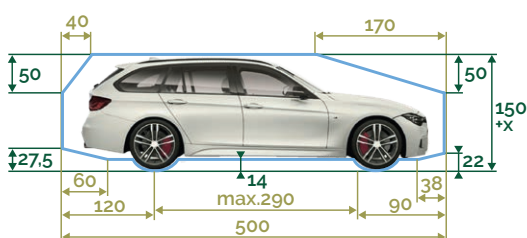

*Vehicle height

Higher cars can be parked on the platform above in case of more ceiling height.

The total vehicle height, including the roof rack, antenna, etc., must not exceed the mentioned maximum height values.

WIDTH DIMENSIONS

DIMENSIONS in cm

ARRANGEMENT IN SEGMENTS

- A = parking width (clear platform width)¹
- B = segment width
- C = additional width (outer segments)²
- D = total width³

parking width	segment width	additional width
A	B	C
230	250	10
240	260	10
250	270	10
260	280	10
270	290	10

We recommend a parking width of at least 250 cm for a comfortable parking.

- 1 The clear parking width of the sliding platform is basically 15 cm smaller than the lifting platform due to its design. Anyway, sufficient space for parking and getting in and out of the car is provided by using low side-carriers.
- 2 An additional width of 10 cm for each of both outer segments is required and included in the total width.
- 3 Tolerance of dimensions on the construction site = 0 to + 3 cm.

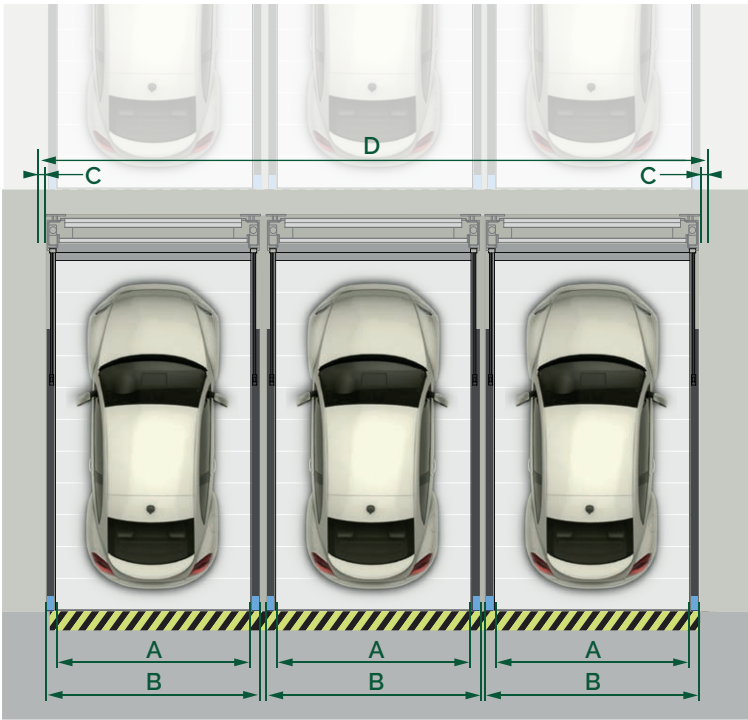

A driving lane in front of each segment is required for access.

DE-613 is available with **10 segments** in 2 rows behind each other for **48 parking spaces**.

parking width A	total width D by x segments								
	2 seg. 8 cars	3 seg. 13 cars	4 seg. 18 cars	5 seg. 23 cars	6 seg. 28 cars	7 seg. 33 cars	8 seg. 38 cars	9 seg. 43 cars	10 seg. 48 cars
230	520	770	1020	1270	1520	1770	2020	2270	2520
240	540	800	1060	1320	1580	1840	2100	2360	2620
250	560	830	1100	1370	1640	1910	2180	2450	2720
260	580	860	1140	1420	1700	1980	2260	2540	2820
270	600	890	1180	1470	1760	2050	2340	2630	2920

WIDTH DIMENSIONS when pillars are in front of the parking area

A	outer seg.	inner seg.	A	outer seg.	inner seg.	inner seg.	inner seg.	A	outer seg.	inner seg.	inner seg.	inner seg.	inner seg.
230	250	230	230	500	480	230	230	230	750	730	230	230	230
240	260	240	240	520	500	240	240	240	780	760	240	240	240
250	270	250	250	540	520	250	250	250	810	790	250	250	250
260	280	260	260	560	540	260	260	260	840	820	260	260	260
270	290	270	270	580	560	270	270	270	870	840	270	270	270

|| min. 20

OPERATION of parking systems



„FDS remote-diagnosis-system“
for a quick online analysis and
reliable diagnosis for smooth
operation .
Available as an option.

To be provided on site:
DSL line with internet access
at the control cabinet.

OPERATION WITH GATES in semi-automatic function by Touch-Screen control unit.

Choose your parking space simply and conveniently by touch screen and follow the movement of your platform on the screen. The control unit is activated by a key-switch to ensure a safe access for permitted users only.

Access gates at the entrance of the system are required for safety reasons.

Mounting of control unit:

Wall mounting (in-wall / surface-mounted).

Alternative mounting options are available upon request.

“Stay comfortably in your car and let the system do the rest.”

Upgrade: Operation by remote control

Each user will receive a coded remote control for its parking space.

By simply pushing the button, the system will provide the selected platform.

The opening and closing of the gates by remote control is only possible when using electrically driven gates. Also external access gates and / or vehicle detectors can be operated by remote control.

GATES

Access gates are required for safety reasons.

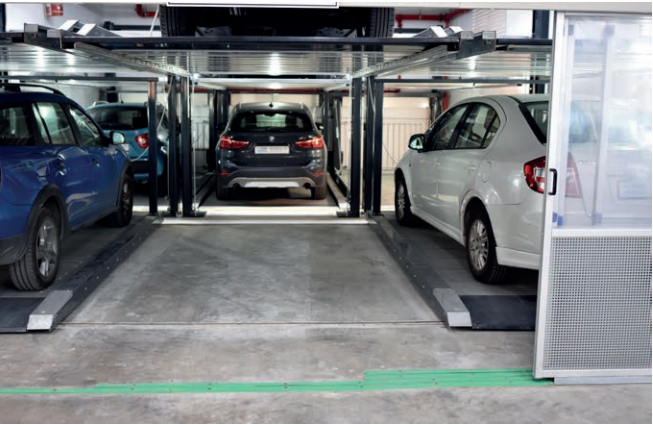
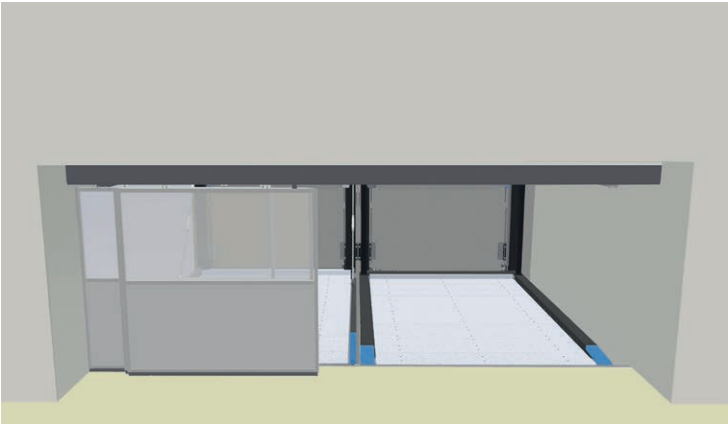

Figure above: DE-611 system for demonstration only.



Our gates offer a wider access area for more comfort and safety.

COMFORT PLUS with our new innovative gates,
we provide a bigger manoeuvring area for easy access and minimized risk of collision.

OPERATION OF GATES

Manual sliding gates (standard)

The gates are opened and closed manually. The locking mechanism is secured by a mechanical lock.

Electric sliding gates (optional)

Electric door drive: The gates are operated semi-automatically via the touch screen control unit of the entire system (function on the touch: open gate/close gate).

FRAME AND FILLUNG

The frame of the gate consists of an aluminum profile with a filling of corrugated mesh (30 mm x 30 mm x 3 mm).

Optional with polycarbonate PC-4 mm.

GUIDANCE AND DRIVE

The gate is mainly guided from above, in the lower area on the finished floor a filigree running rail (polyethylene rail 15 mm high) is pegged to the floor.

The drive technology is also located in the upper area of the frame cover to save space.

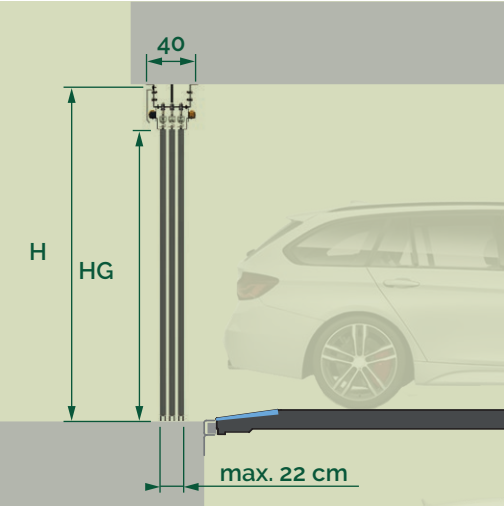

INSTALLATION DATA

H = clear height
HG = entrance height*

H	HG
225 cm	200 cm

Installation depth: 40 cm

***Notes:**

The maximum vehicle height is restricted by entrance height minus 5 cm. Other dimensions, as well as detailed technical information about our innovative sliding gates are available on request

CONSTRUCTION REQUIREMENTS DE-61 (see also planning notes)

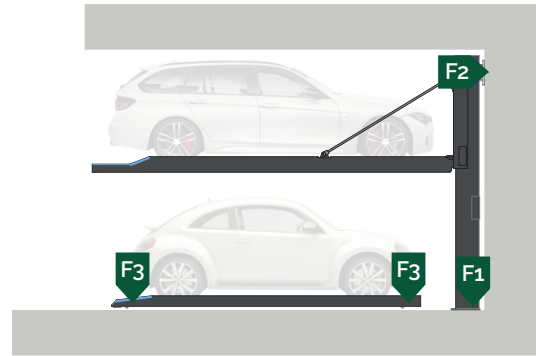
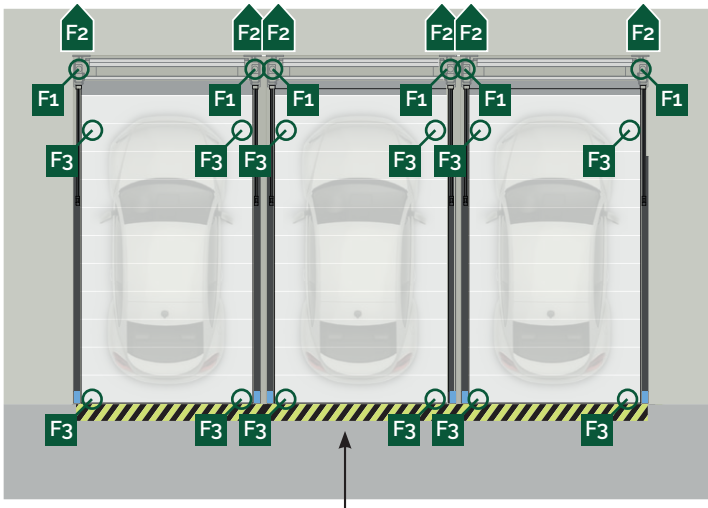

F2 The force F2 can also be absorbed via the ceiling.
Ceiling fixation available upon request.

FORCES TO THE STRUCTURE

	2000 kg	2600 kg
F1	20 kN	25 kN
F2	20 kN	25 kN
F3	8 kN	10 kN

ANCHORING & FLOOR REQUIREMENTS

The systems are directly anchored into the floor with heavy duty anchor bolts. The depth of the drill hole is approx. 13 cm. The base plate thickness must be minimum 20 cm with a concrete quality according to the static requirements of the building. Minimum requirement of the concrete quality is C20/25. The precise position of the load application points is available on request.

Please also adhere to **EVENNESS TOLERANCES TO DIN 18202, table 3, line 3**. Exact levelling of the ground by the customer is essential. The distance between the lower flange of the platforms and the garage ground must not be 2 cm.

ELECTRIC INSTALLATION

To be provided from customer:

Item	Description
1	Electric meter
2	Fuse or automatic circuit breaker according to DIN VDE 0100, part 430, 3 x 16 A slow
3	Supply line to main switch 3 PH + N + PE according to local regs.
4	Main switch lockable
5	Connection for the protective potential equalization according to DIN 60204
6	Protective bonding all 10 m

Power supply and system performance

- power supply: 400 Volt, 50 Hz, 3 phase
- system performance: 3,0 kW

Control cabinet

Size (depth x width x height): 253,5 mm x 511 mm x 711 mm

Position: The control cabinet must be placed outside the moving range of the system. We recommend positioning the cabinet near the system for a better overview of the system. The space in front of the cabinet must be minimum 1 m for opening the door and the operator.

CONSTRUCTION REQUIREMENTS DE-63 (see also planning notes)

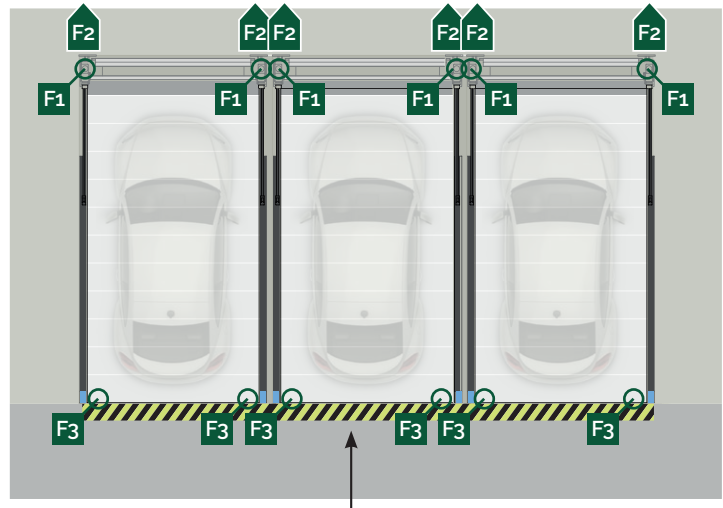
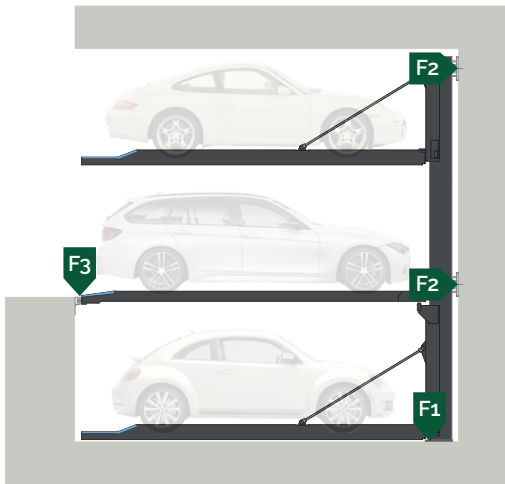

A yellow-black marking in front of each grid, 10 cm wide, according to ISO 3864 has to be provided (on-site)

FORCES TO THE STRUCTURE

	2000 kg	2600 kg
F1	40 kN	48 kN
F2	33 kN	41 kN
F3	8 kN	10 kN

F2 The force F2 can also be absorbed via the ceiling.
Ceiling fixation available upon request.

WALLS

Walls on the entry side and rear are to be made of concrete and completely flat (without protruding parts).

ELECTRIC INSTALLATION

To be provided from customer:

Item	Description
1	Electric meter
2	Fuse or automatic circuit breaker according to DIN VDE 0100, part 430, 3 x 16 A slow
3	Supply line to main switch 3 PH + N + PE according to local regs.
4	Main switch lockable
5	Connection for the protective potential equalization according to DIN 60204
6	Protective bonding all 10 m

ANCHORING & FLOOR REQUIREMENTS

The systems are directly anchored into the floor with heavy duty anchor bolts. The depth of the drill hole is approx. 13 cm. The base plate thickness must be minimum 20 cm with a concrete quality according to the static requirements of the building. Minimum requirement of the concrete quality is C20/25. The precise position of the load application points is available on request.

Power supply and system performance

- power supply: 400 Volt, 50 Hz, 3 phase
- system performance: 3,0 kW

Control cabinet

Size (depth x width x height):

253.5 mm x 511 mm x 7 11mm

Position:

The control cabinet must be placed outside the moving range of the system. We recommend positioning the cabinet near the system for a better overview of the system. The space in front of the cabinet must be minimum 1 m for opening the door and the operator.

PLANNING NOTES



Hydraulic unit

Size (depth x width x height):
approx. 230 mm x 800 mm x 900 mm
Position: Space-saving arrangement
between the columns on the rear wall
or outside the system as per agreement.



Maintenance, cleaning and prevention

The systems must be serviced and
cleaned regularly according to our
operating instructions. Please ensure that
there is sufficient drainage.



Safety fences · Barriers

Must be installed in the pedestrian area,
accessible areas around the system as
per DIN EN ISO 13857 (on site, also during
the installation).



Ventilation

The parking garage must be adequately
ventilated.



Lighting

The parking spaces must be adequately
illuminated on site as per regulations.



Temperature

Temperature range from - 5 to + 40° C.
Relative humidity max. 80 %.
Please contact DE-PARK in case of different
conditions.



Noise emissions

According to the noise insulation regulations
for buildings to DIN 4109, a value of 30 dB (A)
must be complied with in occupied rooms
and spaces. You receive a sound insulation
package with the system for the required
30 dB (A) insulation of the structure is also
necessary. Sound reduction index min. $R_w =$
57 dB.



Fire safety

The garage design must fulfil the regional fire
safety provisions. The requirements can vary.
Therefore the situation must be clarified and
information obtained in advance by the
customer and then agreed and coordinated.



Declaration of conformity

Car Parking Systems of DE-PARK are conform
to EG-Machinery Directive 2006/42/EG and to
DIN EN 14010 (safety).

© DE-PARK GmbH | Technical modifications are reserved | DE-613_V01_2021_04_29_EN



DE PARK

Parking. Surprisingly simple.

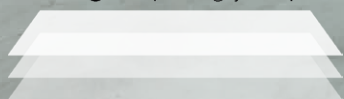

www.de-park.com

DE-PARK GmbH · Zschortauer Str. 76 · DE-04129 Leipzig

Tel.: +49 (0) 341 - 600 16 600 · Fax: +49 (0) 341 - 600 16 602 · info@de-park.com